



**DUROXITE®**

# **DUROXITE®** **WORKSHOP**

- CUTTING
- MACHINING
- FORMING
- WELDING
- ASSEMBLING
- HANDLING



# DUROXITE® IN FABRICATION

**Duroxite® is designed to be hard, without giving you a hard time in the workshop.**

With our broad offering of Duroxite® products you can build, repair and maintain equipment for practically any application challenged by severe sliding wear.

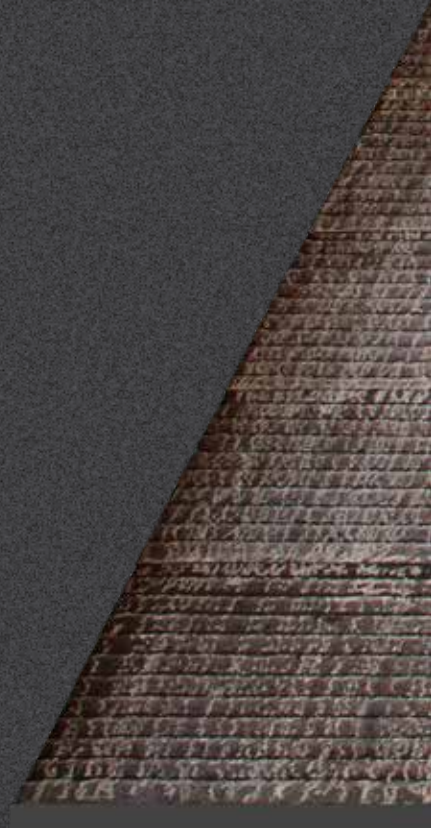



# דורוקסיט®



## PROCESSING AND INSTALLING DUROXITE®

This brochure highlights the main processing and installation techniques for Duroxite®. For further technical advice you are always welcome to contact our Duroxite® specialists. Contact information is found at [duroxite.com](http://duroxite.com) or by scanning the QR code.





# CUTTING

Duroxite® overlay plates can be cut by plasma, laser, water jet, arc gouge, and abrasive saw cutting. However, it cannot be cut by oxy-fuel.

Duroxite® should be cut from the base metal side to avoid carbon contamination. When beveling, Duroxite® plate can be burned from the overlay side.

Cutting speeds need to be reduced compared to regular steel plate cutting because of the carbides.

For safety precautions when cutting Duroxite®, see the welding section in the brochure.

## RECOMMENDED CUTTING SPEED AT DIFFERENT PLASMA CURRENTS AND THICKNESSES

Plate thickness	Duroxite® overlay plate				Carbon steel
	130 amps	200 amps	260 amps	400 amps	360 amps
3 mm on 6 mm 1/8" on 1/4"	1920 mm/min 75 inches/min	2655 mm/min 105 inches/min	3080 mm/min 120 inches/min	3540 mm/min 140 inches/min	4200 mm/min 165 inches/min
6 mm on 6 mm 1/4" on 1/4"	1920 mm/min 75 inches/min	2655 mm/min 105 inches/min	3080 mm/min 120 inches/min	3540 mm/min 140 inches/min	4200 mm/min 165 inches/min
10 mm on 10 mm 3/8" on 3/8"	1010 mm/min 40 inches/min	1265 mm/min 50 inches/min	1735 mm/min 65 inches/min	2440 mm/min 95 inches/min	4200 mm/min 165 inches/min
12 mm on 12 mm 1/2" on 1/2"	552 mm/min 20 inches/min	1225 mm/min 45 inches/min	1465 mm/min 55 inches/min	1800 mm/min 70 inches/min	4200 mm/min 165 inches/min

### CUTTING FROM BASE METAL SIDE



Duroxite® should only be cut from the base metal side to avoid carbon contamination. The cutting surface is smooth, the carbon contamination is eliminated, and there is a clear fusion line to separate overlay from base metal.

### CUTTING FROM HARDFACING SIDE



When cut from the hardfaced side, the overlay materials flow into the base metal. The contamination from the overlay into the base metal cause a higher carbon equivalent, leading to an increased risk of cold cracking when welding.



# MACHINING

Duroxite® is not machinable by conventional methods. Duroxite® can only be finished by grinding because of the extremely hard carbides.

Countersunk holes can be precisely produced by EDM (Electrical Discharge Machining).

Pre-machined steel inserts can be used as an alternative to some conventional machining processes like countersinking, counterboring, and threading. Inserts are machined to fit the profile of fasteners, placed in a clearance hole in the Duroxite® plate, and welded to the backing plate of Duroxite® plate.

**WELDED STUD USED FOR FINAL ASSEMBLY**



**BOLTED LINER WITH MILD STEEL INSERTS**



**MILD STEEL INSERT (BACK SIDE)**



**MILD STEEL INSERT (FRONT SIDE)**



**COUNTERSUNK HOLES USING MILD STEEL INSERTS IN DUROXITE® PLATE**





# FORMING

Duroxite® is typically formed with the overlay to the inside, but can be formed with the overlay to the outside. The staggered cracking pattern on the overlay surface ensures good formability.

Duroxite® plates CANNOT be formed parallel to the welding bead direction. Duroxite® PIPE is recommended for pipes with diameters under 0.6 m (24") instead of pipes fabricating from plate. See charts for minimum forming radius recommendations.

## DUROXITE® 100 AND DUROXITE® 200

Thickness	Min. inside radius* with overlay side in	Min. outside radius* with overlay side out
3 mm on 6 mm 1/8" on 1/4"	305 mm 12"	914 mm 36"
5 mm on 8 mm 3/16" on 5/16"	305 mm 12"	1118 mm 44"
6 mm on 6 mm 1/4" on 1/4"	305 mm 12"	1219 mm 48"
6 mm on 10 mm 1/4" on 3/8"	305 mm 12"	1422 mm 56"
10 mm on 10 mm 3/8" on 3/8"	381 mm 15"	1524 mm 60"
13 mm on 13 mm 1/2" on 1/2"	711 mm 28"	1829 mm 72"

## DUROXITE® 101 AND DUROXITE® 201

Thickness	Min. inside radius* with overlay side in	Min. outside radius* with overlay side out
3 mm on 6 mm 1/8" on 1/4"	305 mm 12"	914 mm 36"
5 mm on 8 mm 3/16" on 5/16"	305 mm 12"	1118 mm 44"
6 mm on 6 mm 1/4" on 1/4"	305 mm 12"	1219 mm 48"
6 mm on 10 mm 1/4" on 3/8"	381 mm 15"	1422 mm 56"
10 mm on 10 mm 3/8" on 3/8"	432 mm 17"	1524 mm 60"
13 mm on 13 mm 1/2" on 1/2"	1067 mm 42"	1829 mm 72"

## DUROXITE® 300 AND DUROXITE® 500

Thickness	Min. inside radius* with overlay side in	Min. outside radius* with overlay side out
3 mm on 6 mm 1/8" on 1/4"	381 mm 15"	1524 mm 60"
5 mm on 8 mm 3/16" on 5/16"	457 mm 18"	1829 mm 72"
6 mm on 6 mm 1/4" on 1/4"	457 mm 18"	1829 mm 72"
6 mm on 10 mm 1/4" on 3/8"	533 mm 21"	2032 mm 80"
10 mm on 10 mm 3/8" on 3/8"	635 mm 25"	2540 mm 100"

\*Imperial measurements are guaranteed. Metric included for reference.



BENDING IN



Bending with hard side facing in closes up the cracks

BENDING OUT



Bending with hard side facing out opens up the cracks

BENDING PARALLEL



Duroxite® plates cannot be formed parallel to the welding bead direction.



# WELDING

When joining plates of Duroxite®, start by joining the base metal with 480 MPa (70 ksi) or 560 MPa (80 ksi) consumables. Any surface exposed to severe wear should be protected with hard-surfacing consumables.

Cap welding a Duroxite® product with Duroxite® WIRE ensures the weld will have the same wear resistance, resulting in a consistent service life for the entire overlay product.

## SAFETY PRECAUTIONS

When welding or cutting Duroxite® products, harmful fumes are produced that are chemically complex and difficult to classify. The major toxic component in the fumes is hexavalent chromium.

Proper exhaust ventilation equipment and fume-extraction torches are recommended, as well as suitable protective clothing and respiratory protection for operators.

**MORE INFORMATION  
ABOUT DUROXITE® WIRE  
AND ELECTRODES IS  
AVAILABLE BY SCANNING  
THE QR CODE OR VISITING  
[www.duroxite.com](http://www.duroxite.com)**



Duroxite® welding consumables come as both wire and electrodes for a variety of welding needs. They are used for production of overlay parts, maintenance and repair work.



**JOINING DUROXITE® PLATE ON MILD STEEL**

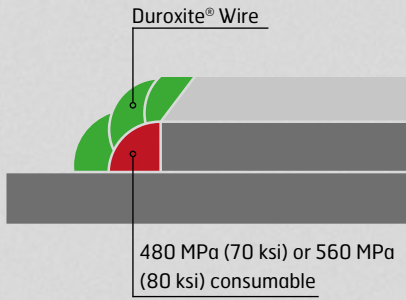

**JOINING DUROXITE® PLATES END TO END (SEE IMAGE BELOW)**

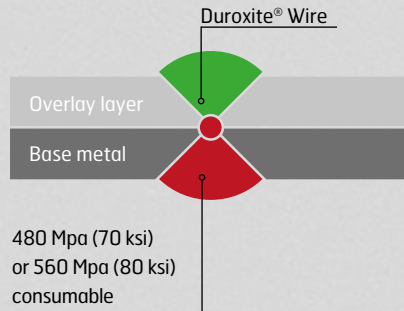

**STUD WELDING OF DUROXITE® PLATE FROM BASE METAL SIDE**

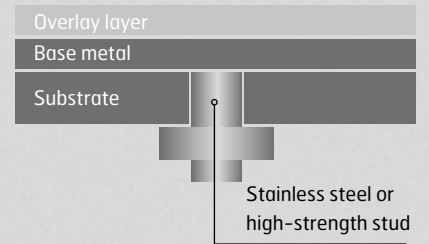

**PLUG WELDING OF DUROXITE® PLATE FROM OVERLAY SIDE**

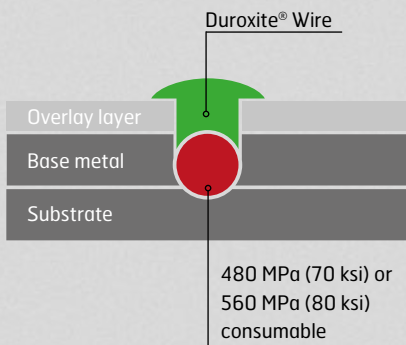

**PLUG WELDING OF DUROXITE® PLATE FROM BASE METAL SIDE**

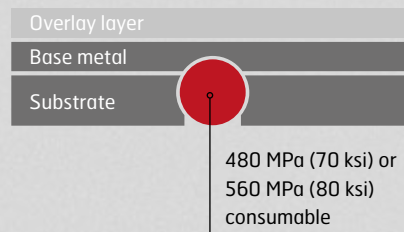

**BOLTING DUROXITE® PLATE THROUGH COUNTERSUNK HOLE**

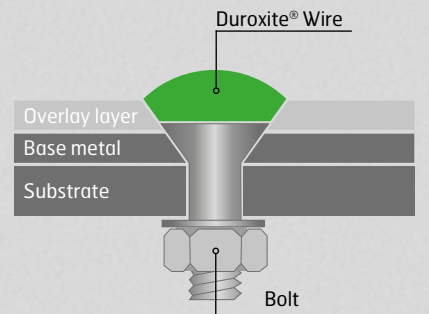

# Joining two Duroxite® plates

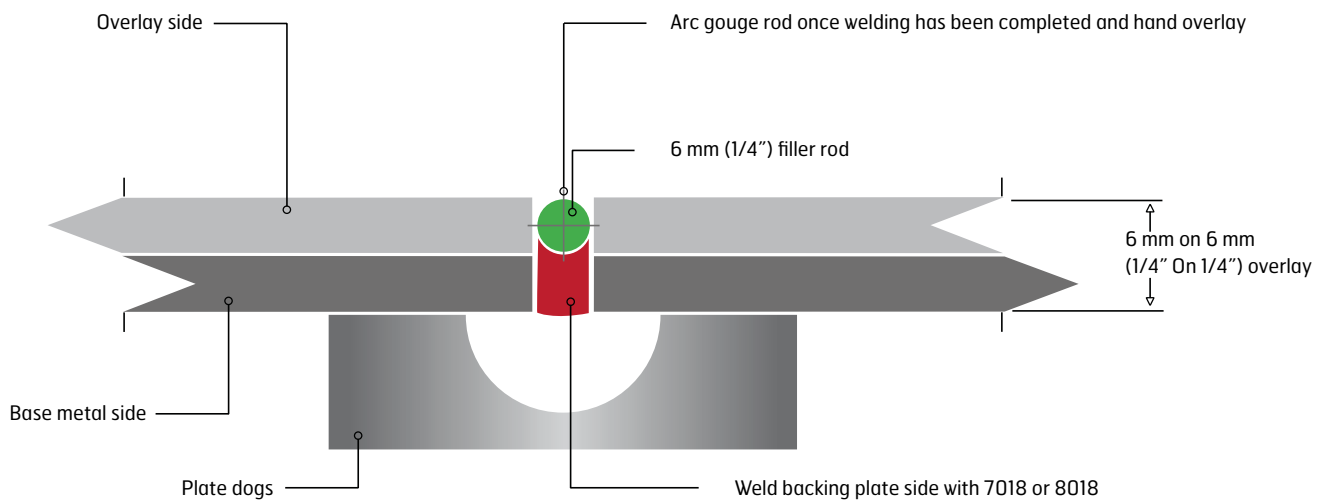

**SPLICING OVERLAY PLATE, DETAIL**

Face overlay side down first. Insert a 6.4 mm (1/4") filler rod and be sure to tack weld below backing plate. Install plate dogs to prevent plate distortion. Weld backing plate side, flip plate over, and arc gouge filler rod out. Fill gap flush with Duroxite® Wire. Turn plate back to backing plate side and remove plate dogs.



# ASSEMBLING

## FILL WELDING

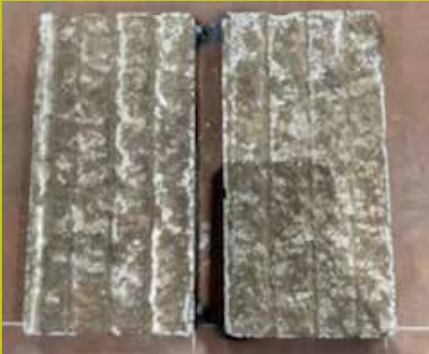

Before welding two pieces of 10 mm on 10 mm (3/8" on 3/8") Duroxite® 200.

## FILL WELDING



Use 560 MPa (80 ksi) low carbon wire to join mild steel substrate of Duroxite® 200.

## FILL WELDING



Use 1.6 mm (1/16") Duroxite® 200 Wire to cap the weld with two passes.

## PLUG WELDING



Before welding a Duroxite® 200 10 mm on 10 mm (3/8" on 3/8") plate with an oval hole.

## PLUG WELDING



Use 560 MPa (80 ksi) low carbon joining wire to fill the base of the hole.

## PLUG WELDING



Use 1.6 mm (1/16") Duroxite® 200 Wire to cap the weld with two passes.

## PLUG WELDING HOLE



Before welding a Duroxite® 200 10 mm on 10 mm (3/8" on 3/8") plate with a 150 mm (6") diameter hole.

## PLUG WELDING HOLE



Cut a 125 mm (5") diameter disc from a 10 mm on 10 mm (3/8" on 3/8") Duroxite® 200 plate and weld only the substrate of the disc and hole to the plate using 560 MPa (80 ksi) low alloy joining wire.

## PLUG WELDING HOLE



Use 1.6 mm (1/16") Duroxite® 200 Wire to cap the weld with two passes.





Spalling has occurred on edges of the liner plates because the gap between the liners was not properly filled with hardfacing wire.



FILL WELDING



Duroxite® plates welded together with the gaps properly filled between liners to prevent spalling.



PLUG WELDING



Plug filling of the oval hole when attaching a piece of Duroxite® plate to an excavator bucket.



PLUG WELDING HOLE



Plug filling of round holes to attach a Duroxite® liner plate on the bucket's inside.



# BEAD ORIENTATION

Theoretically, when abrasives flow at a 45 degree angle relative to the welding bead orientation of the overlay plate, it gives optimum wear resistance. This can however be difficult to achieve in practical applications.

For a Duroxite® plate with straight welding beads, it is recommended to apply the plate with the abrasives flowing across the welding beads, at a transverse orientation.

When abrasives flow along the welding bead orientation it reduces the wear resistance. That is why the ASTM G65 wear test sample is cut at this orientation to evaluate the worst case scenario.



# REPAIRING AFTER CUTTING

When cutting Duroxite® plates, chipping or spalling may occur at the corners of a plate. This rare issue is caused by transverse cracks in Duroxite® plates, which are formed to relieve residual stress during welding. To address this, we recommend following the touch-up procedures outlined below.

BEFORE REPAIRING



Chipped corner after cutting.

AFTER WELDING



Thicker overlay is welded away from the corner, thinner overlay at the edge.

AFTER GRINDING



The repaired surface should be ground to become smooth and round.



# LIFTING, HANDLING AND TRANSPORTING

Duroxite® plates are flat when delivered to facilitate cutting on plasma and laser machines. While handling and transporting, it is important the plates are supported by stiff beams that stretch the entire length of the plates to avoid buckling and bending.



Duroxite® plates should always be supported when handling and transporting to ensure they stay flat.



# LEARN MORE AT

# [www.duroxite.com](http://www.duroxite.com)



Duroxite® is a trademark of the SSAB group of companies. All rights reserved.  
The information contained in this brochure is provided only as general information. SSAB AB accepts no responsibility for the suitability or appropriateness for any specific application. As such, the user is responsible for any and all necessary adaptations and/or modifications required for specific applications.

# DUROXITE®